

# User Manual

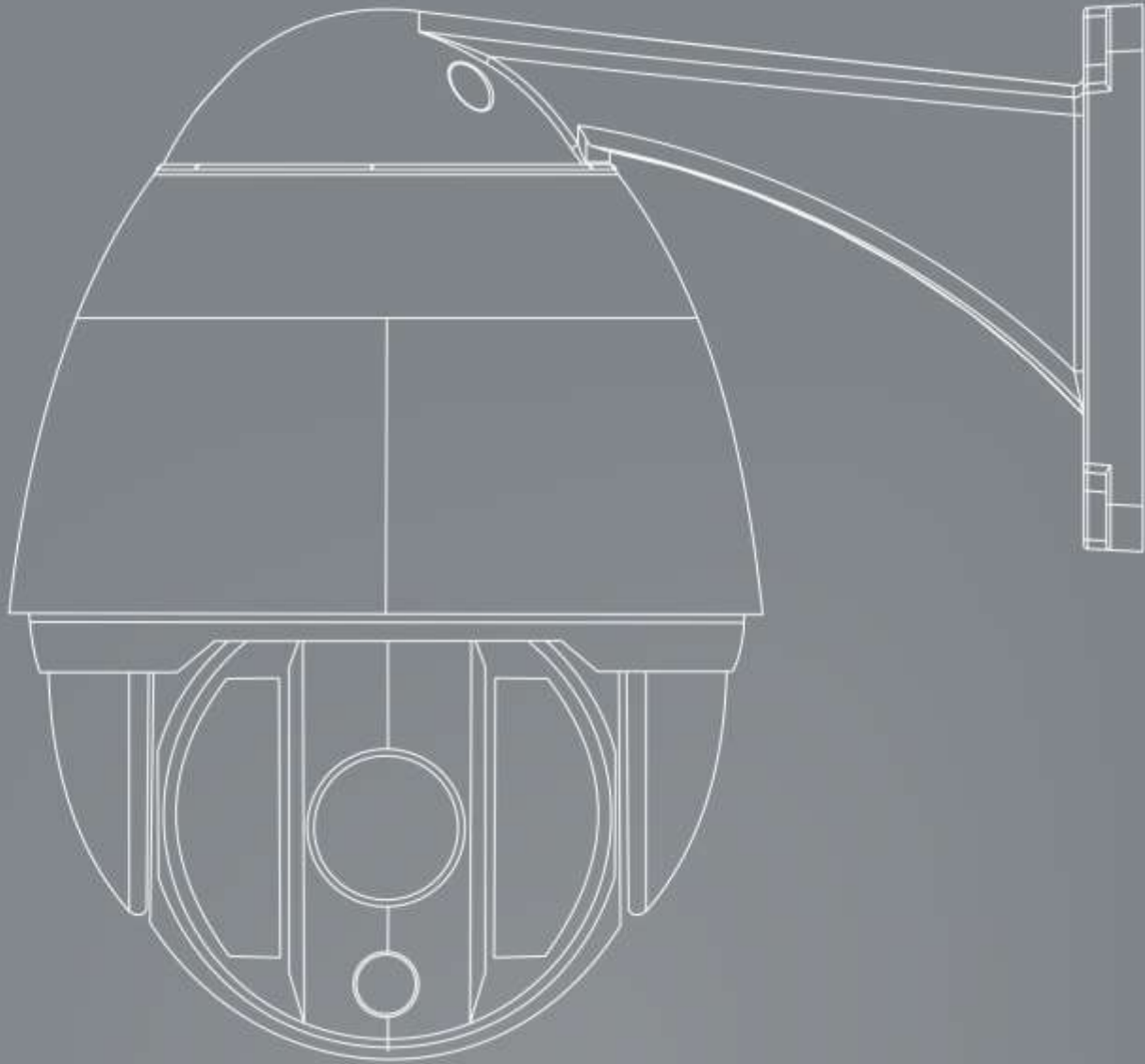

## Intelligent High Speed Dome



# **Intelligent High Speed Dome Camera**

## **Operation Manual**

(English Version)

Please read this manual carefully before installation and use  
(Announcement: This manual will be subject to revision without further  
notification)



**Precautions:**

1. Non-technician is forbidden to operate this dome device before reading this manual carefully.
2. Cut the power supply off before operating the dome device to avoid damage caused by mal-operation.
3. Interior of the Dome device are precision optical and electrical instruments. Heavy pressure, shock and other incorrect operations should be prevented. Otherwise, may cause damage to the product.
4. Please do not remove or disassemble any internal parts of dome video camera by self in order to avoid normal usage being impacted. There is no part inside the device, which can be repaired by users themselves.
5. All the wiring of the dome device should be conducted strictly according to the wiring instruction. When necessary, thunder-proof, surge-proof and other protecting measures should be carried out.
6. Please do not use the product under the situations of exceeding specified temperature, humidity or power supply specifications.

# Content

<b>Chapter One Product Overview .....</b>	<b>1</b>
I. Performance instruction: .....	1
II. Featured Functions Instruction:.....	1
<b>Chapter Two Wiring and Setup of Dome System .....</b>	<b>3</b>
I. Wiring of Dome System.....	3
II. Setting of Dome Device communication .....	4
<b>Chapter Three Fast Operation Guide of Dome Device.....</b>	<b>6</b>
I. Wiring . .....	6
II. Setting protocol and baud rate. ....	6
III. Setting dome device address.....	7
IV. Install camera. ....	7
V. Connect the power of dome device .....	7
VI. Controller setting.....	7
VII. Start testing .....	8
VIII. Complete the test. (Summary).....	8
<b>Chapter Four -English Operation Menu of Dome Device .....</b>	<b>10</b>
I. Operation Instructions .....	10
II. Tree Menu List.....	11
1.Language Options .....	12
2.Display Options.....	12
3.Control Options.....	15
4.System Options .....	19
5.Camera Options.....	21
6.Camera Options ( For 4 inch SpeedDome ) .....	23
7.Function Programming .....	27
8. User Admin .....	34
9. Date/Time .....	35
<b>Chapter Five Short-cut Operations and Specification of Dome Device.....</b>	<b>39</b>
<b>Chapter Six Main Technical Parameters .....</b>	<b>41</b>
<b>Chapter Seven Trouble Shooting of Dome Device.....</b>	<b>42</b>



## Chapter One Product Overview

### I. Performance instruction:

- 1. Address of dome device is from 0~255.** The number (address) of dome device in the control system is setup by the hardware (8-digit on and off switch) of dome device.
- 2. Integrated multi-protocol and auto protocol differentiation. Note:** The dome device only auto differentiate controller of the first communication.
- 3. Pan 360° continuous rotation.**
- 4. Tilt 90° action plus 2° angle adjustment.** Plus the 2 degree adjustment, the view angle is -2° ~ 90° .
- 5. Pan manual operation speed range from 0.1° to 240° /S .**
- 6. Tilt manual operation speed range from 0.1° to 180° /S .**
- 7. 256 preshot positions.** (A fixed position that aimed by the dome camera, which can be set and revised by user arbitrarily)
- 8. The maximum running speed when preshot is being called can reach 240° /S with accuracy of ±0.1° .**
- 9. Compatible with many kinds of Module Camera.** (Sony, Hitachi, Sanyo, Yoke, CNB, LG, Samsung)
- 10. Power supply: AC24V/3.5A**
- 11. Easy installation interface.**
- 12. Pass environmental protection grade IP66 .** (outdoor type)
- 13. Adopts long distance RS-485 transmission mode**
- 14. Transmission speed, i.e. baud rate is selectable .** (Set by the fifth and sixth bit of the on and off switch of the dome device. 2400bps~19200bps)

### II. Featured Functions Instruction:

- 1. Multi-language operation menu and function display.**
- 2. Display of camera name, operation position and angle.** (The name of the camera can be edited and the coordinate angle of the dome device can be displayed on the screen.)
- 3. Operation crosshair function.** (With crosshair on the screen, the target can be captured more effectively.)
- 4. 6 PTZ tours operation with 2 minutes record of each tours.** (Can real-time monitor and record the action of manual operation)
- 5. 8 groups of programmable vector scans.** (including scan speed, dwell time, preshot and interruption between tours)
- 6. Vertical auto flip function with 10° automatic forward tracing**
- 7. 8 zones of programmable sectional mask.** (Can mask part of the sectors of camera, which differs depending on camera types)



8. **8 sectors of programmable sectional display.** (Can display the name and nature of concrete position shooting by the camera, which differs depending on different types of camera)
9. **150m IR distance, and the IR Mode adjustable.** (Far, Near, Far+Near, Auto, Close)
10. **The dome device will auto enter into function running after self-test or no communication for a certain time.** (Dwell time can be set from 1 to 999 seconds)
11. **Image frame freezing function.** (freez picture function)
12. **Operation return function.** (after executing operation return, the dome device will return to the previous operation)
13. **Intelligent manual scan function.** (execute this function in manual pan operation, you can adjust the manual pan operation)
14. **Intelligent power off real time memory.** (If power was cut off when a certain function is in operation, the dome device can resume working at where the power is cut off.)
15. **High efficient 3-dimension scan.**
16. **Camera zoom in speed limit function.** (When it was zooming in, the speed of the dome device will auto slow down.)
17. **User management .** (User can be divided into administrator and general operators)
18. **Operation authorization .** (Administrator can perform setup of respective authorities for general operators)
19. **Display & setting of date& time .**
20. **Assignment programming.** (timed operation function) (Users can assign different operation for the dome as per needed.)
21. **Timer of startup and shutdown .** (Users can set the operating time for the dome as per actual use situation, to extend the life of the product.)
22. **Strong alarm and warning mechanism .** (User can set automatically enable or disable alarm as well as its operating time and mode for various alarm inputs and outputs of the dome according to actual situation.)
23. **Real-time temperature display .** (User can ON/OFF the display of real-time operating temperature of the dome)
24. **Temperature alarming setting.**
25. **High-temperature shutdown setting**
26. **Notice: Different control equipment , The operation method is different, please refer to the users manual of the control equipment at the same time**
27. **IR-LED and Zoom module are linkage, IR-LED switch near mode and far mode according to the zoom times**
28. **Manual to control IR-LED advance or delay open**



## Chapter Two Wiring and Setup of Dome System

### I. Wiring of Dome System

#### 1. Basic system connection (One dome device)

From the basic system connection, user can understand the electric wiring attribute of the dome device and bring great operation convenience of installation, testing and demo. When using this product for the first time, please read carefully and follow this electric wiring drawing as any wrong wiring may lead to permanent damage of the dome device or damage of other equipment.

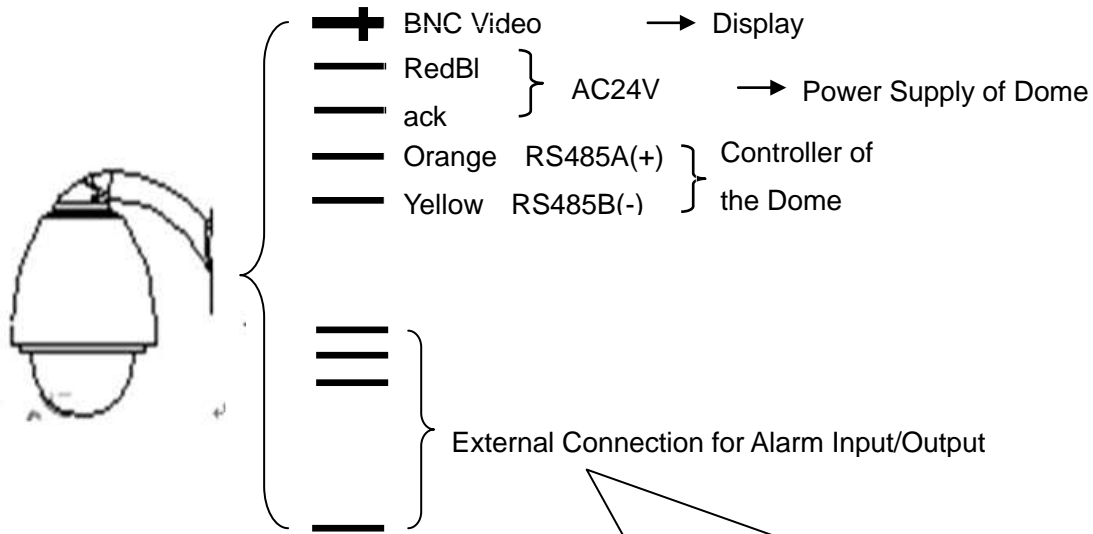

Description about Connections for Alarming Function:

No.1 Alarm Input: Red and White  
 No.2 Alarm Input: Yellow and White  
 No.3 Alarm Input: Brown and White  
 No.4 Alarm Input: Blue and White

No.1 Alarm Constant ON Output (NO1) : Blue and Green  
 No.1 Alarm Output Public Terminal (COM1) : Blue

No.2 Alarm Constant ON Output (NC2) : Brown and Green  
 No.2 Alarm Output Public Terminal (COM2) : Green

**!Attention: No operation when the dome device is power on.**



## 2. Multi-dome device connection

When connecting many dome devices together, the user can embed multi-device system with auxiliaries such as arrester device, video matrix, DVR and alarm box for system integration.

**AC24V:** Power supply of dome device, which will convert 110V/60Hz or 220V/50Hz input to AC 24V output and supply to the dome device.

**RS-485 Bus:** It is for the control signal(RS-485 signal)output of controller, connecting to the communication input terminals of control cable of each dome device.

**Video:** It is for image signal output of dome device, (can directly output to video equipment such as monitor or video matrix. Take care of the match up of impedance.)

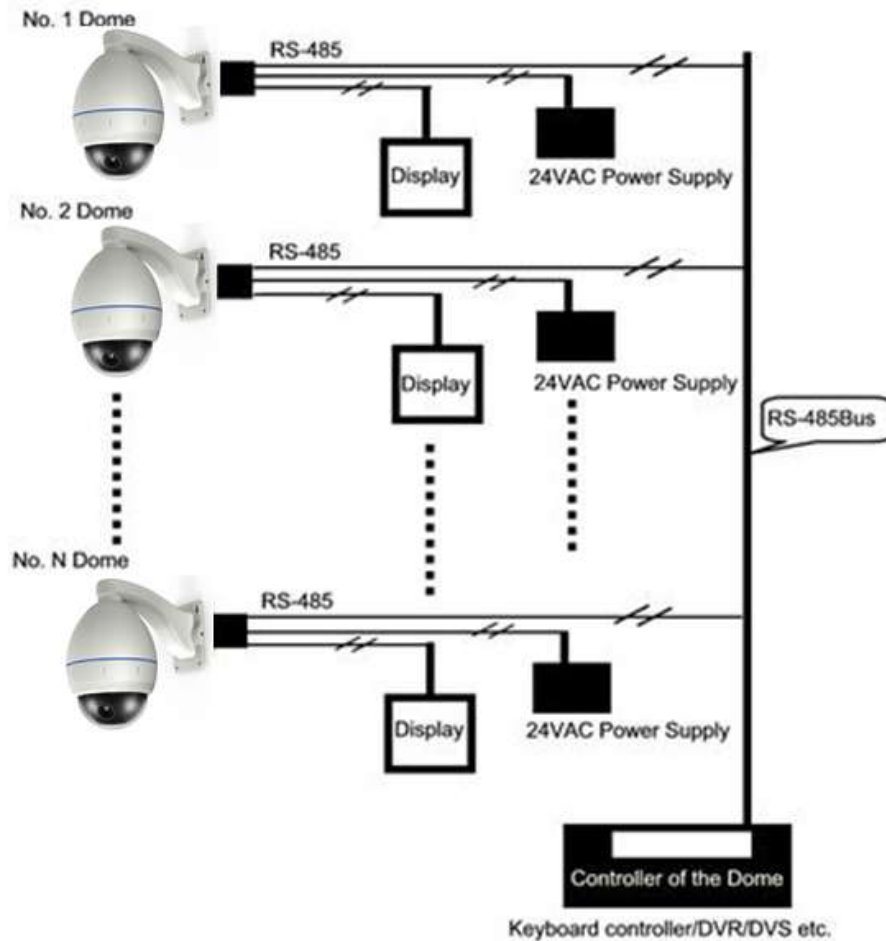

## II. Setting of Dome Device communication

Before installation and use, the setting of communication protocol and transmission speed (baud rate) should comply with the control system.

1. Setting protocol and baud rate of dome device.



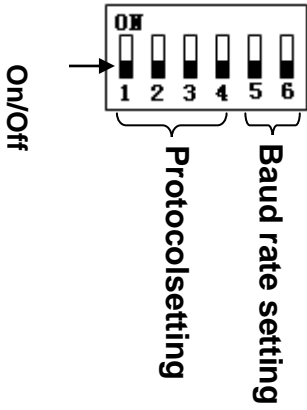

On/Off status Protocol type	1 <sup>st</sup> digit	2 <sup>nd</sup> digit	3 <sup>rd</sup> digit	4 <sup>th</sup> digit	5 <sup>th</sup> digit	6 <sup>th</sup> digit
PELCO-D	ON	ON	OFF	OFF	**	**
PELCO-P	OFF	ON	OFF	OFF	**	**
DYNACOLOR	ON	OFF	OFF	OFF	**	**
ULTRACK	OFF	OFF	ON	OFF		
VICON	OFF	OFF	OFF	OFF	**	**

**Attention:** the protocol and baud rate of dome device should comply with those of controller, which need to be restarted after revision.

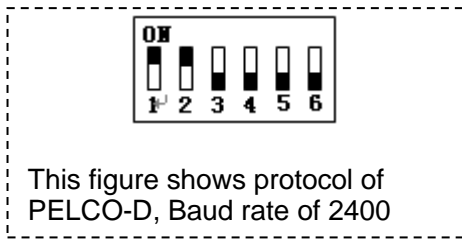

On/Off status Baud rate	5 <sup>th</sup> digit	6 <sup>th</sup> digit
2400	OFF	OFF
4800	OFF	ON
9600	ON	OFF
19200	ON	ON

2. Address setting of dome device

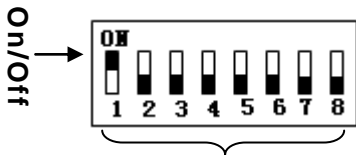

Setting address for dome device (this figure shows the address of dome device No 1).

Dome device range: 0~255.

**Setting method:** The sum of switch numbers when it is at ON position is the address of dome device.

On/off switch and matching numbers

Calculation example of dome device address:



## Chapter Three Fast Operation Guide of Dome Device

### I. Wiring . (Please do not turn the power on)

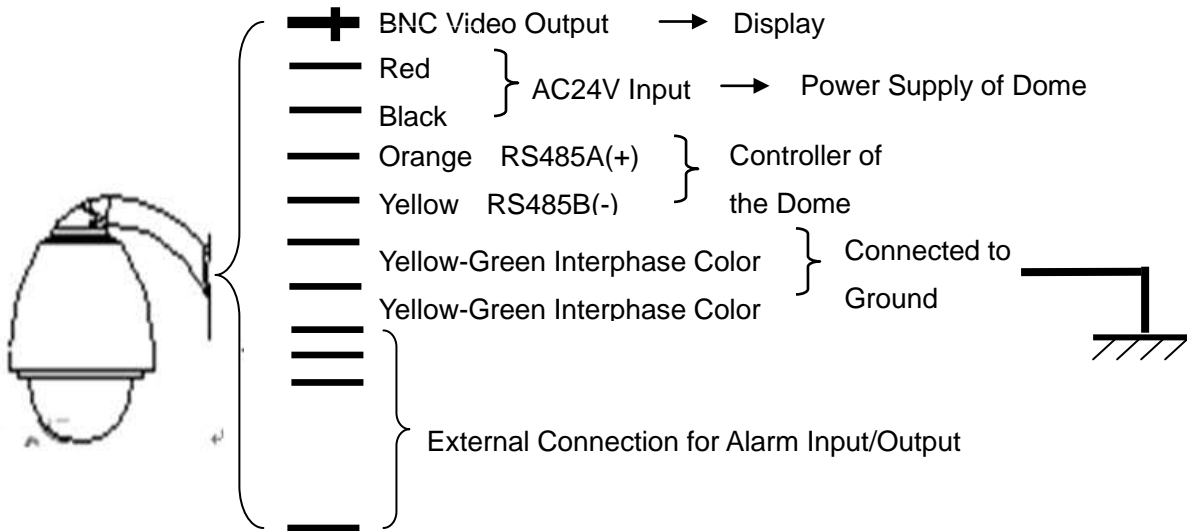

**!Attention: No operation when the dome device is power on.**

### II. Setting protocol and baud rate (Turn the power off when setting, and restart the device after revision)

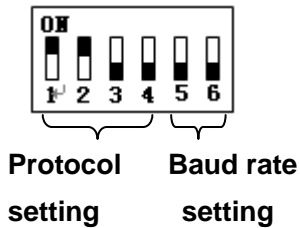

The figure shows: Protocol: **PELCO-D**  
Baud rate: **2400 bps**

(Please refer to detailed parameter in next chapter)

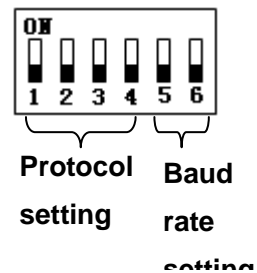

The figure shows: Auto detection protocol.  
Baud rate: **2400bps**

(Please refer to detailed parameter in next chapter)



### III. Setting dome device address.

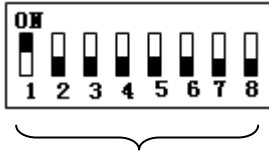

Set address for dome

The figure shows: Address of the dome device: No. 1

(Please refer to detailed parameter in next chapter)

*This dip switch located on PCB in the dome device*

### IV. Install camera. (Please refer to camera installation for details)

- Attention:** 1.Do not connect the camera and dome device with FFC in a wrong way.  
2.The installation holes of different camera differ.

### V. Connect the power of dome device

At this moment, the self-test (rotation) of dome device and self-test (there will be image on the monitor) of camera can be seen.

**Attention:** When the dome device is self-testing, it is normal when sound is issued caused by the block of dome device after 2~5 seconds of vertical movement, which is the tilt orientation of the dome itself.

### VI. Controller setting

**Set the protocol, baud rate and address of the keyboard controller identical with those of dome device.** (Please refer to keyboard controller instruction manual).

**Attention:** If the setting of protocol of dome device is auto detection, the protocol of keyboard controller can be set arbitrarily. But its baud rate should be set identical with that of the dome device.



## VII. Start testing

When all the above are ready, the testing to dome device can be started.

### 1. Direction control test of dome device

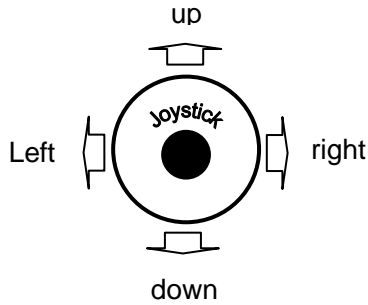

The directions (up, down, left and right) of the dome device can be controlled by using the keyboard controller, as indicated in the figure.

**Note:** the working of dome device is normal

### 2. Zooming control test of camera

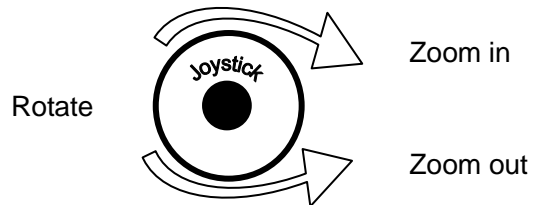

Zooming of the camera can be controlled by zooming function Joystick or by using TELE (zoom in) and WIDE (zoom out) on the keyboard button.

**Note:** The camera and dome device are normal

**(Please refer to the next section for demonstration of menu operation and control of dome device.)**

## VIII. Complete the test. (Summary).

1. If the performance of item 7 is normal, it indicates the system is basically normal. Please do not change the wiring and various setting to avoid fault and unnecessary damage and loss.
2. If the performance of item 7 is abnormal, or only one item works normally, please check the wiring (item 1 and 4) and setting (item 2, 3 and 6) carefully.





## Chapter Four -English Operation Menu of Dome Device

### I. Operation Instructions

#### <1>. Menu Operation Instructions

1. Input tilt movement command for cursor movement and option selection, namely the controller moves the joystick upward and downward, hereinafter called as: **Joystick Up/Down**
2. Input pan movement command for entering into option or changing the setting value, namely the controller joystick leftward and rightward, hereinafter called as: **Joystick Left/Right**
3. Input the iris Open command for confirming setup or changing value, namely the controller presses the iris OPEN command, hereinafter called as **Press OPEN**
4. Input the iris Close command to cancel the setting or exit, namely the controller presses the iris CLOSE command, hereinafter called as **Press CLOSE**

#### <2>. Number Input Steps Instructions:

1. Joystick left/right for the cursor to select the data bit to be entered.
2. Press **OPEN** to confirm and the number selection cursor would open and display, as indicated in the pictures.
3. Joystick left/right for the cursor to select the number to be entered.
4. Press **OPEN** to confirm, the selected number would be displayed on corresponding data bit.
5. Number of respective data bits are input as above.
6. Press **CLOSE** to confirm and exit when it is completed.

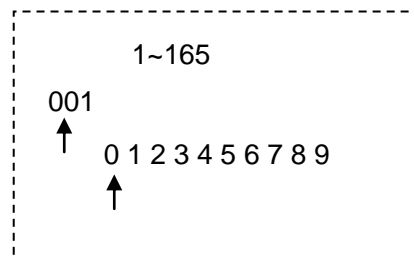
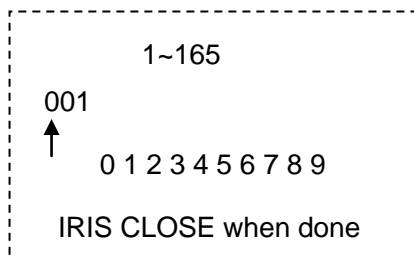

#### <3>. Character Input Steps Instruction (See the pictures).

1. Joystick left/right for the cursor to select the position of the characters to be entered.
2. Press **OPEN** to confirm, and enter into the character area selection and input interface.
3. Joystick left/right for the cursor to select the characters to be entered.
4. Press **OPEN** for confirmation.
5. Input other characters respectively as above.
6. Press **CLOSE** and save for exit when it is completed.

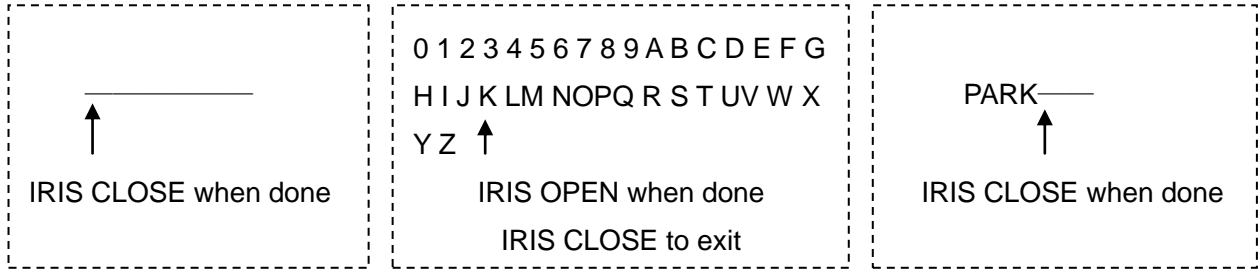

### <4>. Users Logon Operation

1. Please invoke No.92 preset position for administrator’s logon.

Please invoke No.93 preset position for the logon of operator.

**Factory Password:** Administrator: 000000 Operator: 111111

**Attention :** Administrator password must be properly kept. While the dome shall be returned to the factory if it is lost.

2. Move the cursor after entering the *Please enter the Password* interface. Select the bit to be entered. Then press **OPEN** (Input the iris OPEN command) to enter the password data selection interface and press **OPEN** to confirm. Input the correct 6 digits passwords as above.

After the input is completed, press **CLOSE** (Input the iris CLOSE command). *Error* will be prompted on screen if the input is wrong. The screen will directly enter into the window to be operated if the input is correct.

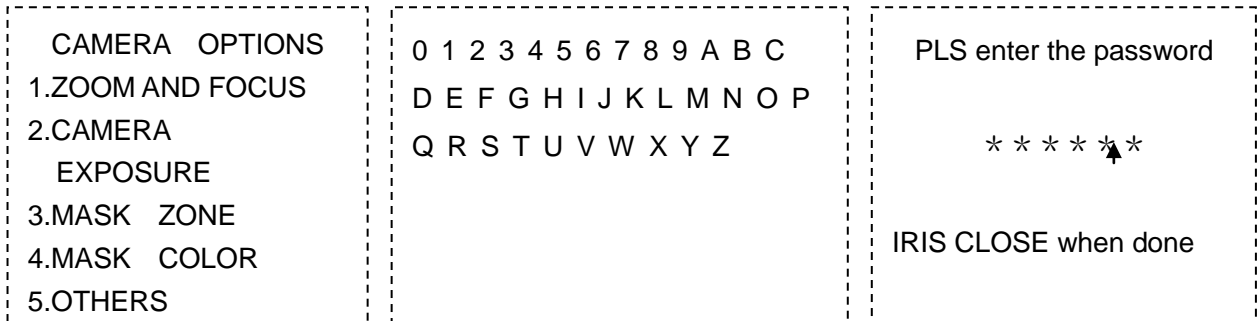

## II. Tree Menu List.

<1>.Main menu. Press 90+PRE to enter the main menu.

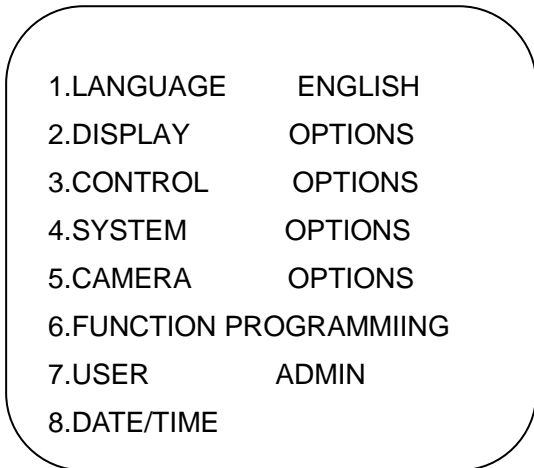



<2>.All sub-menus can be seen clearly in this tree list

### 1.Language Options(English/Espanol/Polски)

<<Language options

**Jovstick left/right to select**

### 2.Display Options

<<Display options

**Press OPEN or Jovstick left/right to enter**

#### 2.1.PRESET SETUP

<<Preshot setup options

①.Number 1

<<Preshot number selection

**Press OPEN or Jovstick left/right to enter**

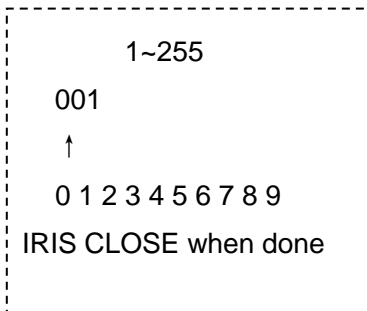

<<The default number after entering is 001. (hundred bit/ten bit/single bit). Joystick left/right to select preshot position and press **OPEN** to confirm, and Joystick left/right again to select numbers (0~9). Press **OPEN** to confirm the selection. Press **CLOSE** to exit to upper stage menu when programming is done.

②.SET PRESET

<<Set preshot

**Press OPEN or Jovstick left/right to enter**

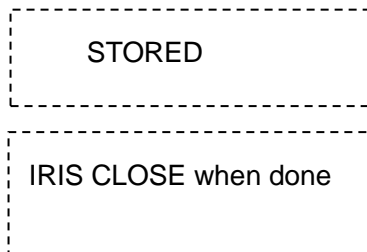

Move the cursor to select preset position. Press **CLOSE** to finalize your selection. The screen displays **Stored** and return to the previous menu then.

③.Call PRESET

<<Call preshot

**Press OPEN or Jovstick left/right to enter**

Select the number needed to be called from Number option. Joystick up/down to select Call Preshot menu. Joystick left/right or press **OPEN** then the lens auto switch from current preset position to corresponding number.





④.Delete PRESET

<<Delete preshot.

**Press OPEN or Joystick left/right to enter**

Select the number needed to be deleted from Number option. Move the cursor to select Delete Preshot. Joystick left/right or press **OPEN** to enter into Delete Preshot menu. Press **OPEN** to confirm the selection or **CLOSE** to cancel the selection and exit

Are you sure to do this?  
IRIS OPEN to confirm  
IRIS CLOSE to cancel

<<Reminder: Are you sure to delete preshot?  
Press **OPEN** to confirm  
Press **CLOSE** to exit to upper stage menu.

⑤.Name \_\_\_\_\_

<<Edit the name of preshot.

**Press OPEN or Joystick left/right to enter**

\_\_\_\_\_  
↑  
IRIS CLOSE when done

Press **OPEN** to enter

0 1 2 3 4 5 6 7 8 9 A B C D  
E F G H I J K L M N O P Q  
R S T U V W X Y Z \_  
  
IRIS OPEN when done  
IRIS CLOSE to exit

<<Joystick left/right when programming to select preshot and press **OPEN** to confirm.

Joystick left/right to select (0~~9 or A~~Z). Press **OPEN** to confirm selection.

Press **CLOSE** to exit to upper stage menu when programming is done.

⑥.Name Display ON

<<Name display On/Off

**Joystick left/right to select**

**IRIS CLOSE to exit**

## 2.2.Sector Setup

<<Sector setup

**Press OPEN or Joystick left/right to enter**

①.Number 1

<<Number selection ( 1 ~ 8 )

**Joystick left/right to select**

②.Name \_\_\_\_\_

<<Name editing

**Press OPEN or Joystick left/right to enter**



↑  
IRIS CLOSE when done

Press **OPEN** to enter

0 1 2 3 4 5 6 7 8 9 A B C D E  
F G H I J K L M N  
↑  
O P Q R S T U V W X Y Z \_  
IRIS OPEN when done

<< Joystick left/right when programming to select preshot and press **OPEN** to confirm.

Joy stick left or right to select (0~9 or A~Z). Press **OPEN** to confirm selection.

Press **CLOSE** to exit to upper stage menu when programming is done.

③.Pan Start POS 0.0

IRIS CLOSE when done

④.Pan End POS 0.0

IRIS CLOSE5 when done

<< Setup pan end point **Press OPEN or Joystick left/right to enter**

Using joystick to capture pan end point. Press **CLOSE** to confirm and

⑤.Tilt Start POS 0.0

IRIS CLOSE when done

<< Setup tilt start point. **Press OPEN or Joystick left/right to enter**

Using joystick to capture tilt start point. Press **CLOSE** to confirm and exit to upper stage menu.

⑥.Tilt End POS 0.0

IRIS CLOSE when done

<< Setup tilt end point **Press OPEN or Joystick left/right to enter**

Using joystick to capture tilt end point. Press **CLOSE** to

⑦.Name Display ON

<<Sector name display On/Off **Joystick left/right to**

**select**

**IRIS CLOSE to exit**

### 2.3.Coordinates ON

<<Coordinates display On/Off

**Joystick left/right to select**



**2.4.Crosshairs OFF**

<<Crosshairs On/Off

**Joystick left/right to select**

**2.5.Start-Up Scr Msg ON**

<<Start-up screen message display On/Off

**Joystick left/right to select**

**2.6. OSD Style NORMAL**

<<The style of OSD menu Normal

**Joystick left/right to select**

**2.7. Dome Name Setup**

<<Setup The Name Of The dome

**Joystick left/right to select**

1.DOME NAME  
 2.NAME DISPLAY  
 OFF

↑  
 IRIS CLOSE when done

**Press OPEN to enter**

**IRIS CLOSE to exit**

**3.Control Options**

<<Control options

**Press OPEN or Joystick left/right to enter**

**3.1.Set Pan and Tilt**

<<Pan/Tilt setup of dome device

**Press OPEN or Joystick left/right to enter**

- |                     |     |                       |        |                               |
|---------------------|-----|-----------------------|--------|-------------------------------|
| ① Pan Reverse       | OFF | << Pan Reverse        | ON/OFF | <b>Joystick left/right to</b> |
| ②.Tilt Reverse      | OFF | << Tilt Reverse       | ON/OFF | <b>Joystick left/right to</b> |
| ③. +2 Tilt Limit    | OFF | <<+2 Tilt Limit       | ON/OFF | <b>Joystick left/right to</b> |
| ④.Find Home On Sta. | ON  | << Find Home on start | ON/OFF | <b>Joystick left/right to</b> |

**IRIS CLOSE to exit**



### 3.2. Set default function

<<Set Home Position

**Press OPEN or Joystick left/right to enter**

①.Default function P/V/T

<<Select default function (Preshot/Tour/PTZ)

**Press OPEN or Joystick left/right to enter**

②.Number 1

<< Function number selection

**Press OPEN or Joystick left/right to enter**

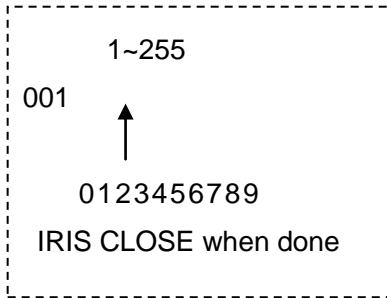

<< Joystick left/right when programming to select preshot and press **OPEN** to confirm. Joy stick left or right to select (0~9). Press **OPEN** to confirm selection. Press **CLOSE** to exit to upper stage menu when programming is done.

③.Delay 60

<<Time delay setting (second)

**Press OPEN or Joystick left/right to enter**

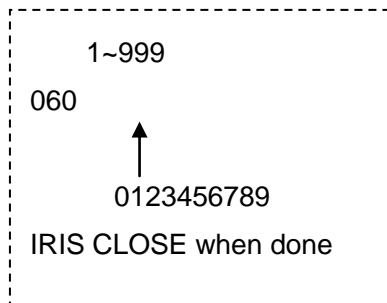

<< Joystick left/right when programming to select preshot and press **OPEN** to confirm. Joystick left/right to select (0~9). Press **OPEN** to confirm. Press **CLOSE** to exit to upper stage menu when programming is done.

④.Operation OFF

<<Default function On/Off

**Joystick left/right to select**

**IRIS CLOSE to exit**

### 3.3.Speed Limit ON

<<Operation speed limit On/Off

**Joystick left/right to select**

### 3.4.Auto Flip ON

<<Auto flip On/Off

**Joystick left/right to select**



**3.5.Auto Focus            PTZ**

<<Auto focus options PTZ/Off/Z

**Joystick left/right to select**

**3.6.Auto AE                PTZ**

<<Auto AE option PTZ/Off/Z

**Joystick left/right to select**

**3.7.VectorScan AF        OFF**

<<VectorScan auto focus control On/Off

**Joystick left/right to select**

**3.8.VectorScan Still     OFF**

<< VectorScan Still On/Off

**Joystick left/right to select**

**IRIS CLOSE to exit**

**3.9.IR SETUP**

1.IR-MODE	AUTO
2.IR BRIGHTNESS	8
3.SENSITIVITY	17
4.STANDBY MODE	OFF
5.STANDBY POWER	OFF
6.STANDBY TIME	3
7.LIGHT INTENSITY	30
IRIS CLOSE to cancel	

**3.9.1. IR MODE        OFF**

<< IR MODE CLOSE/AUTO/NEAR/FAR/F+N

**Joystick left/right to select**

**IRIS CLOSE to exit**

**3.9.2. IR BRIGHTNESS    8**

<< IR MODE 1~30

**Press OPEN or Joystick left/right to enter**



```

1~30
060

0123456789
IRIS CLOSE when done

```

<< Joystick left/right when programming to select preshot and press **OPEN** to confirm. Joystick left/right to select (0~9). Press **OPEN** to confirm. Press **CLOSE** to exit to upper stage menu when programming is done.

### 3.9.3. SENSITIVITY 8

<< SENSITIVITY 1~30

**Press OPEN or Joystick left/right to enter**

```

1~30
060

0123456789
IRIS CLOSE when done

```

<< Joystick left/right when programming to select preshot and press **OPEN** to confirm. Joystick left/right to select (0~9). Press **OPEN** to confirm. Press **CLOSE** to exit to upper stage menu when programming is done.

### 3.9.4. STANDBY MODE OFF

<< STANDBY MODE OFF

**Joystick left/right to select**

**IRIS CLOSE to exit**

<< When you don't operate the dome for a time, the IR dome will be in the standby mode, it can reduce the power of the dome, and it protect the IR-LED

### 3.9.5. STANDBY POWER 8

<< SENSITIVITY 1~30

**Press OPEN or Joystick left/right to enter**

```

1~30
060

0123456789
IRIS CLOSE when done

```

<< Joystick left/right when programming to select preshot and press **OPEN** to confirm. Joystick left/right to select (0~9). Press **OPEN** to confirm. Press **CLOSE** to exit to upper stage menu when programming is done.

<< Adjust the Power of standby mode, and 1~30



**3.9.6. STANDBY TIME 8**

<< SENSITIVITY 1~999

```

1~999
060

0123456789
IRIS CLOSE when done

```

**Press OPEN or Joystick left/right to enter**

<< Joystick left/right when programming to select preshot and press **OPEN** to confirm. Joystick left/right to select (0~9). Press **OPEN** to confirm. Press **CLOSE** to exit to upper stage menu when programming is done.

<< Adjust the leisure time to enter standby mode

**3.9.7. LIGHT INTENSITY 8**

<< SENSITIVITY 8

<< it can't be setup, it shows the light intensity of surrounding environment, and it is automatically change

**4. System Options**

<< System options

**Press OPEN or Joy stick left or right to enter**

**Function Description:** This option is used for data information management of the dome. The operating authority on this option is only limited to the administrator with correct password.. As to administrator password input, refer to *Number Input Steps Instructions*.

**4.1. Clear Memory**

<< Clear data in the memory

**Press OPEN or Joystick left/right to enter**

```

Are you sure to do this?
IRIS OPEN to confirm
IRIS CLOSE to cancel

```

<<Reminder: are you sure to do this.

Press **OPEN** to confirm.

Press **CLOSE** to exit and return to upper stage menu.

**4.2. Restore Def Setting**

<< Restore default setting

**Press OPEN or Joystick left/right to enter**

```

Are you sure to do this?
IRIS OPEN to confirm
IRIS CLOSE to cancel

```

<< Reminder: are you sure to do this.

Press **OPEN** to confirm.

Press **CLOSE** to exit and return to upper stage menu.



### 4.3.Color System PAL/NTSC

<< PAL/NTSC switch

**Joystick left/right to select**

### 4.4. Reset Dome

<< Restart the syetem of the Dome

```

-----
Are you sure to do this?
IRIS OPEN to confirm
IRIS CLOSE to cancel
-----

```

<<Reminder: are you sure to do this.

Press **OPEN** to confirm.

Press **CLOSE** to exit and return to upper stage menu.

### 4.5.Dome Information

<<Dome information

**Press OPEN or Joystick left/right to enter**

```

-----
Camera:FCB-EX1020P
Protocol:Pelco-D
Baud rate: 2400
Dome No.:1
COMM MODE:HW
SN      :10000084
      IRIS CLOSE to exit
-----

```

<<Type of camera

<<Control protocol

<<Baud rate

<<Dome number

<<Communication Mode

<<Serial Number

<<Press **CLOSE** to exit and return to upper stage

**IRIS CLOSE to exit**

### 4.6.Comm Setings

<< Comm Setings

**Joystick left/right to select**

① COMM MODE HW/SW

<< Hardware ID Adress/Software ID Adress

**Joystick left/right to select**

② Dome ID 1

< ID Adress Of The Dome

<

**Joystick left/right to selectit can be set only by the R/W mode of the comm seting**

③ Baud Rate 1

<< Baud Rate Of The Dome

**Joystick left/right to selectit can be set only by the R/W**

**mode of the comm seting**





④INPUT SN **Joystick left/right to select**

⑤SN  
 <<Serial Number **N/A**

#### 4.7 Camera Memory OFF/ON

<< Automatic default for the last model of the Camera **Joystick left/right to select**

### 5. Camera Options

<< Camera options **Press OPEN or Joystick left/right to enter**

**For example:** Sony Camera, the menu has differences according to different cameras.

#### 5.1. Zoom and Focus

<< Zoom and Focus **Press OPEN or Joystick left/right to enter**

①.Zoom Speed 7  
 << Zoom Speed 1~8 **Joystick left/right to select**

②.Digital Zoom OFF  
 <<Digital Zoom ON/OFF **Joystick left/right to select**

③.AF Sensitivity High  
 << AF Sensitivity High/Low **Joystick left/right to select**

**IRIS CLOSE to exit**

#### 5.2. Camera Exposure

<< Camera Exposure **Press OPEN or Joystick left/right to enter**

①AE Mode AUTO  
 <<AE Mode AUTO/Manual/Shutter/Iris/Bright **Joystick left/right to select**

②Slow Shutter ON  
 << Slow Shutter ON/OFF **Joystick left/right to select**

③Shutter Speed Auto  
 << Shutter Speed Auto **Joystick left/right to select**

④Iris Level Auto  
 << Iris Level Auto **Joystick left/right to select**







**For example:** Samsung Camera, the menu has differences according to different cameras.

### 6.1. CAM TITLE

<< The Title of the camera

**Press OPEN or Joystick left/right to enter**

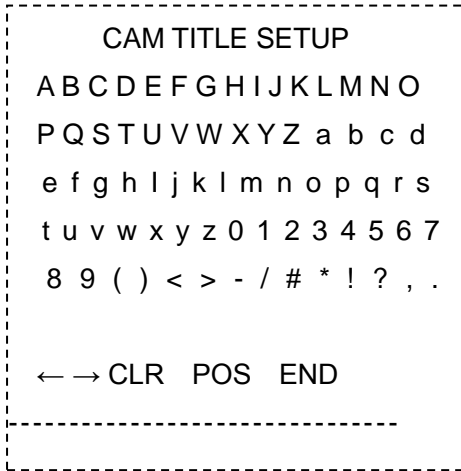

Move the joystick to select the character for names.  
Press OPEN to confirm the selection and select

**IRIS CLOSE to exit**

### 6.2. WHITE BAL

<< White Balance

**Press OPEN or Joystick left/right to enter**

①. ATW <<Auto Track Balance the color automatically depending on the source of light

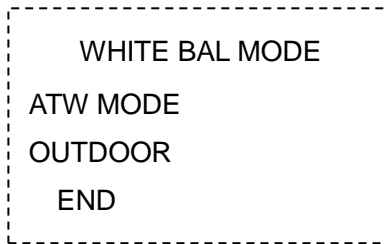

ATW-OUTDOOR: Use this mode under broad color temperature

ATW-INDOOR: Use this mode under limited color temperature

**Choose "END" , Press OPEN to Exit**

②. MANUAL << Manual White Balance

**Joystick left/right to select**

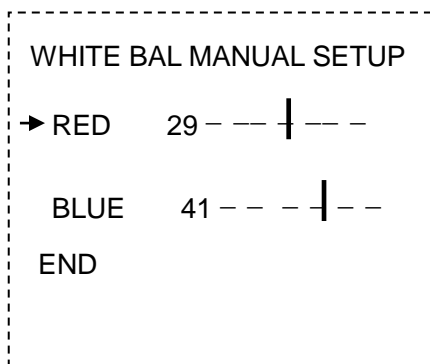

**Joystick left/right to select**



**Choose "END" And Press OPEN to Exit**

③. AWC→SET << Auto White Correct **Joystick left/right to select**

Set up the lighting to the objects and correct the color temperature to that of a white object. Camera will work under the selected parameters..

**6.3. BACKLIGHT OFF/Low/Middle/High**

<< Backlight Compensation **Joystick left/right to select**

- ① **HIGH:** Gain increased from 6dB up to 34dB
- ② **MIDDLE:** Gain increased from 6dB up to 30dB
- ③ **LOW:** Gain increased from 6dB up to 18dB
- ④ **OFF:** BLC function is disabled

**6.4. MOTION DET OFF/ON**

<< Mask Color **Joystick left/right to select, Press OPEN Enter**

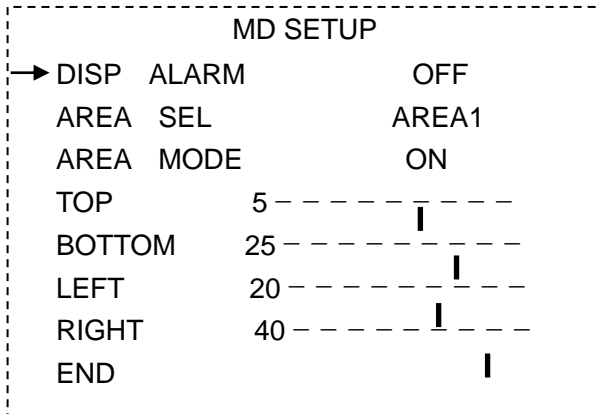

- ①. DISP ALARM ON/OFF **Joystick left/right to select**
- ②. AREA SEL AREA1/AREA2/AREA3/AREA4 **Joystick left/right to select**
- ③. AREA MODE ON/OFF **Joystick left/right to select**
- ④. TOP 0~255 **Joystick left/right to select**
- ⑤. BOTTOM 0~255 **Joystick left/right to select**



- ⑥.TOP                    0~255                    **Joystickleft/righttoselect**
- ⑦.TOP                    0~255                    **Joystickleft/righttoselect**

**Choose “END” , Press OPEN to Exit**

### 6.5. Focus

**Press OPEN or Joystick left/right to enter**

- ①. MODE      AUTO/ONE-PUSH/MANUAL                    **Joystick left/right to select**

AUTO            The camera adjusts the focus automatically while monitoring the screen continuously in the auto mode.

ONE-PUSH      Only if the camera is not moving, it turns into the manual mode. Same controls as manual

MANUAL        The user can adjust the focus manually

- ②. ZOOM TRK    The focus function is executed when the zoom function is ON. The speed of zoom-in goes fast or slow following the zoom speed

- ③ Zoom Speed            FAST/SLOW.                    **Joystick left/right to select**

- ④.D-ZOOM                OFF/2X/10X                    **Joystick left/right to select**

- ⑤. DISP ZOOM MAG    OFF/ON    Display available figure for zoom in/out on screen

- ⑥ ZOOM POS INIT      OFF/ON    Initiate the zoom position                    **Joystick left/right to**

**sel**

- ⑦. LENS INIT                                    Initiate the lens to default setting                    **Press OPEN to**

**confirm**

### 6.6. EXPOSURE

**Press OPEN or Joystick left/right to enter**

- ①. BRIGHTNESS            0~100                    **Joystick left/right to select**

- ②. IRIS                    Auto/Manual                    **Joystick left/right to select**

- ③. SHUTTER      Manual/A.FLK                    **Joystick left/right to select**

**Manual :** Shutter speed can be adjusted manually from 1/50 to 1/120000 of a second



**A.FLK** : Use this mode when the screen flickers because of inconsistent frequency of surrounding lights.

④. AGC          NORMAL/HIGH/OFF          **Joystick left/right to select**

⑤. SSNR          OFF/LOW/MIDDLE/HIGH          **Joystick left/right to select**

⑥. SENS-UP      OFF/AUTO          **Joystick left/right to select**

manually from x2-x128 when it is in AUTO mode

### 6.7. Special Setting

**Press OPEN or Joystick left/right to enter**

```

SPECIAL SETUP
USER PRESET      ON
PRIVACY            ON
DAY/NIGHT
AUTO1
SYNC                INT
COMM ADJ
IMAGE ADJ
END

```

**Joystick left/right to select**

### 6.8. RESET

**Setup**

**Press Open to Initiate The Camera**

### 6.9. EXIT

**Press Close To Exit The Camera Menu**

## 7.Function Programming

<<Special function programming

**Press OPEN or Joystick left/right to enter**

### 7.1.PTZ Tour (Pattern)

<<Pan/Tilt/Zoom tour programming

**Press OPEN or Joystick left/right to enter**



①.Number ( 1 ~3 )

<<PTZ tour number

**Joystick left/right to select**

②.Name

<<Edit PTZ name

**Press OPEN or Joystick left/right to enter**

```

-----
↑
IRIS CLOSE when done

```

**Press OPEN to enter**

```

0 1 2 3 4 5 6 7 8 9 A B C D E F G H I J
K L M N
↑
O P Q R S T U V W X Y Z _
IRIS OPEN when done
IRIS CLOSE to exit

```

<<Joystick left/right when programming to select preshot and press **OPEN** to confirm. Joystick left/right to select (0~~9 or A~~Z). Press **OPEN** to confirm. Press **CLOSE** to exit to upper stage menu when programming is done.

③. Program a Tour

<<Enter PTZ tour programming

**Press OPEN or Joy stick left or right to enter**

```

-----
IRIS OPEN to begin
-----
IRIS CLOSE when done
-----

```

<<Press **OPEN** to confirm and start programming.

<<Press **CLOSE** to exit the programming and return to upper stage menu

④.Run a Tour

<<Run Pan/Tilt/Zoom tour (pattern)

**Press OPEN or Joy stick left or right to enter**

Joystick left/right to select pending running tour from Number option. Joystick up/down to select Run a Tour menu. Press OPEN or joystick left/right to run the selected tour. Move the joystick in any direction to cancel the tour and return to previous menu.

⑤.Delete a Tour

<<Delete PTZ tour

**Press OPEN or Joy stick left or right to enter**

Joystick left/right to select pending deleting tour from Number option. Joystick up/down to select Delete a Tour menu. Press OPEN or joystick left/right to enter.





Are you sure to do this?  
 IRIS OPEN to confirm  
 IRIS CLOSE to cancel

<< Reminder: are you sure to do this.  
 Press **OPEN** to confirm.  
 Press **CLOSE** to exit and return to upper stage menu.

⑥Name Display ON/OFF  
 <<PTZ tour name display On/Off

**Joy stick left or right to select**

**IRIS CLOSE to exit**

### 7.2.Program VectorScan

<< Program vector scan

**Press OPEN or Joy stick left or right to enter**

①.Number 1  
 <<Vector scan number ( 1 ~ 6 )

**Joystick left/right to select**

②.Program a VectorScan  
 <<Vector scan programming

**Press OPEN or Joy stick left or right to enter**

Program VectorScan 1

	name	num	v	dwll
1	-	-	-	-
2	-	-	-	-
3	-	-	-	-
16				

IRIS CLOSE when done

<<Joystick arbitrarily to move the cursor, and stop the cursor at place of programming.  
 Press **OPEN** to enter the selection.

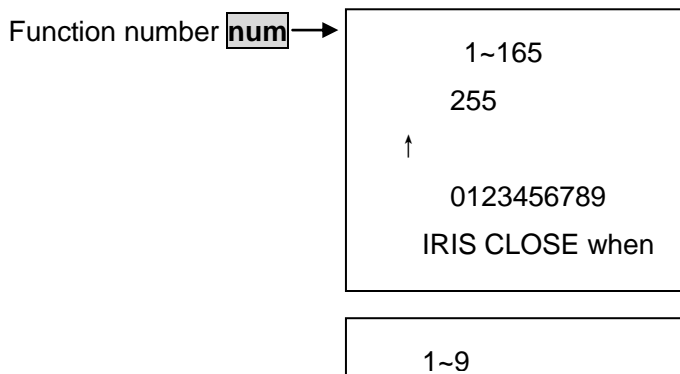
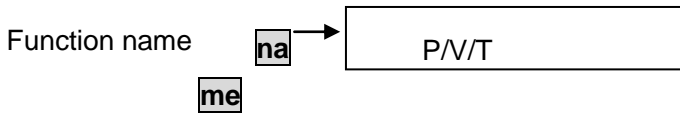

<<Joystick left/right when programming to select preshot and press **OPEN** to confirm.  
 Joy stick left or right to select (0~9).  
 Press **OPEN** to confirm. Press **CLOSE** to exit or return to upper stage menu when programming is done.

<< Press OPEN continuously



Velocity selection **V** →

Dwell time **dwell** →

1~99

55

↑

0123456789

IRIS CLOSE when done

<<Joystick left/right when programming to select preshot and press **OPEN** to confirm.  
 Joy stick left or right to select (0~9).  
 Press **OPEN** to confirm. Press **CLOSE** to exit or return to upper stage menu when programming is done.

③.Run a VectorScan

<<Run vector scan

**Press OPEN or Joystick left/right to enter**

Joystick left/right to select pending running vectorscan from Number menu.Joystick up/down to select Run aVectorScan menu. Press OPEN or joystick left/right to run selected vectorscan track..Move the joystick in any direction to cancel it and display Program VectroScan menu again

④.Delete a VectorScan

<<Delete vector scan

**Press OPEN or Joystick left/right to enter**

Joystick left/right to select pending deleting vectorscan track from Number menu.Joystick up/down to select Delete a VectorScan menu. And joystick left/right or press OPEN to make your selection.  
 Press OPEN to confirm or CLOSE to cancel your selection and return to previous menu

Are you sure to do this?

IRIS OPEN to confirm

IRIS CLOSE to cancel

<< Reminder: Are you sure to do this.  
 Press **OPEN** to confirm.  
 Press **CLOSE** to exit and return to upper stage menu.

**IRIS CLOSE to exit**

### 7.3.Program Alarm

<< Alarm Programming

**Press OPEN or Joystick left/right to enter**

**Functional Description:** The product has totally 8 channels of alarm input and 2 channels of alarm output. User can achieve a strong alarm mechanism and early warning mechanism through flexiable programming setup.

① Alarm In Programming

**Press OPEN or Joystick left/right to enter**

A) Channel Number 1



<<Channel number (1~8)

**Joystick left/right to select**

B) Sensor Type NO

<< Sensor Type NO/NC

**Joystick left/right to select**

**Note:** Sensor Type namely means the alarm input status when alarm has not happened. OFF indicates that the output switch of the alarm detector is disconnected when alarming situation has not happened, and the switch is closed when alarm occurs. This is the contrary to ON status.

C) Operation Time

<< Operation Time

**Press OPEN or Joystick left/right to enter**

a) Mode Eachday

<< Mode

**Joystick left/right to select**

Eachday/Workday/Weekend/Mon/Tue/Wed/Thurs/Fri/Sat/Sun

b) Enable Time Setup

<< Enable time setup

**Press OPEN or Joystick left/right to enter**

Default time: 00:00:00 Refer to *Number Input Steps Instructions* for details.

Enable Time Setup	
→ 1 Hour	0
2 Minute	0
3 Second	0
IRIS CLOSE to exit	

Disable Time Setup	
→ 1 Hour	23
2 Minute	59
3 Second	59
IRIS CLOSE to exit	

c) Disable Time Setup

<< Disable time setup

**Press OPEN or Joystick left/right to enter**

Default time: 23:59:59 Refer to *Number Input Steps Instructions* for details.

**IRIS CLOSE to exit**

D) Lable Edit \_\_\_\_\_

<< Notice Lable

**Press OPEN or Joystick left/right to enter**

Refer to *Character Input Steps Instructions* for details

E) Lable Display OFF

<< Lable display ON/OFF

**Joystick left/right to select**

F) Matter Setup

<< Matter Setup

**Press OPEN or Joystick left/right to enter**

a).Matter PreShot

<< Matter

**Joystick left/right to select**



PreShot/Vector/Tour/PanScan/DayNight/PicStill

b).Number 1

<< Number (Default: 1)

**Joystick left/right to select**

Refer to *Number Input Steps Instructions* for details.

**Note:** Effective only for PreShot/VectorScan/PTZ Tour

c).Dwell Time 60

<<Dwell time Default:60

**Press OPEN or Joystick left/right to enter**

Refer to *Number Input Steps Instructions* for details.

**IRIS CLOSE to exit**

G) Priority 1

<< Priority (1~8)

**Joystick left/right to select**

H) Channel Enable OFF

<< Channel Enable ON/OFF

**Joystick left/right to select**

※ If it is set as ON, the dome will take corresponding actions or cautions according to user setting of this channel when alarming situation appears.

※ If it is set as OFF, this channel will be closed. It will make no response no matter there is alarming situation or not.

**Note:**

※ Alarm has the top priority among all the non-functional setting status.

(Including manual and automatic executed cruising or scanning functions)

※ User who has the operation authority can disable the alarm through manual or auto way.

Situation 1. If alarm occurs when user is scanning manually, the manual scan will be stopped for alarm execution. It will enter the next round of alarm only when alarm is disabled.

Situation 2. It will disable the alarm during non-operation time.

Situation 3. When the alarm inputs of the same priority grade appear, the channel with smaller number will be first executed.

**IRIS CLOSE to exit**

②Alarm Out Programming

**Press OPEN or Joystick left/right to enter**

A) Channel Number 1

<< Channel number (1~2)

**Joystick left/right to select**

B) Notice Label \_\_\_\_\_

<< Label Edit

**Press OPEN or Joystick left/right to enter**

Refer to *Character Input Steps Instructions* for details

C) Label Display OFF



<< Label Display ON/OFF **Joystick left/right to select**

D) Trigger Alarm in 1  
<< Trigger Alarm in 1-8 **Joystick left/right to select**

E) Enable OFF  
<< Enable ON/OFF **Joystick left/right to select**

F) Dwell Time 60  
<< Dwell time Default:60 **Press OPEN or Joystick left/right to enter**

Refer to *Number Input Steps Instructions* for details.

**IRIS CLOSE to exit**

### 7.4.Mask Zone (NA)

<<Mask Setting **Reserved**

### 7.5. Temperature PROG

<< Temperature Programming **Press OPEN or Joystick left/right to enter**

①. Display OFF  
<< Display ON/OFF **Joystick left/right to select**

②. Power Off Temp +85  
<< Power Off Temperature **Press OPEN or Joystick left/right to enter**

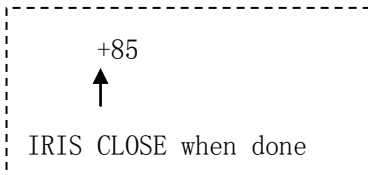

Press OPEN continuously to choose “+” or “-”

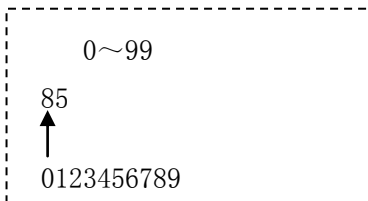

Refer to *Number Input Steps Instructions* for details

**IRIS CLOSE to exit**

### 7.6.Mask Zone (NA)

<<Mask Setting **Reserved**



## 8. User Admin

<<User Management

**Press OPEN or Joystick left/right to enter**

**Note:** The authority belongs only to the administrator.

### 8.1 Master Setup

<<Master setup

**Press OPEN or Joystick left/right to enter**

① Password Edit

**Press OPEN or Joystick left/right to enter**

<<Edit password

Refer to *Number Input Steps Instructions* to set new password according to screen display during operation. If setup is correct, the screen will prompt *Done!*. Otherwise, *Error!* will be prompted.

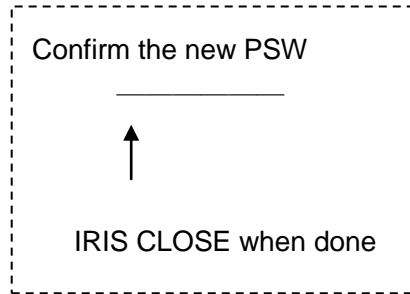
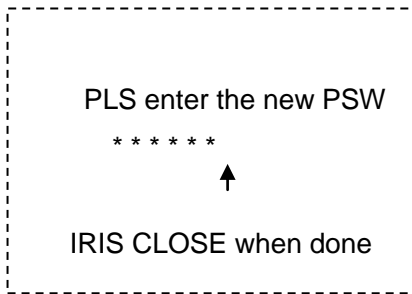

② Operation Lock OFF

<< Operation Lock ON/OFF

**Joystick left/right to select**

③ Wait 120

<< Wait

**Press OPEN or Joystick left/right to enter**

Refer to *Number Input Steps Instructions* to set up time.

- Note:**
- a) If the operation lockup function is enabled and no controlled command is received within the specified waiting time, the dome will lock up the operation until a successful re-login.
  - b) Operational lockup of all-level users is only effective to its own level.

**IRIS CLOSE to exit**

### 8.2 Operator Setup

<<Operator seup

**Press OPEN or Joystick left/right to enter**

Refer to *Master Setup* section for details.



### 8.3 Authorization

<<Authorization

**Press OPEN or Joystick left/right to enter**

**Note:** The setup under this option is the configuration of general users' operating authorities by the administrator. If certain function is set as ON, it indicates that this function is open to general users. Otherwise the screen will show "No Authorization"

① Program PreShot	OFF	<<Program PreShot	ON/OFF	Joystickleft/righttosele
② Call PreShot	ON	<<Call PreShot	ON/OFF	Joystickleft/righttoselect
③ Camera Setup	OFF	<<Camera Setup	ON/OFF	Joystickleft/righttosele
④ Program PTZ Tour	OFF	<<Program PTZ Tour	ON/OFF	Joystickleft/righttosele
⑤ Run PTZ Tour	ON	<<Run PTZ Tour	ON/OFF	Joystickleft/righttosele
⑥ Program VectorScan	OFF	<<Program VectorScan	ON/OFF	Joystickleft/righttosele
⑦ Run VectorScan	ON	<<Run VectorScan	ON/OFF	Joystickleft/righttosele
⑧ Program Date/Time	OFF	<<Program Date/Time	ON/OFF	Joystickleft/righttosele
⑨ Program Alarm	OFF	<<Program Alarm	ON/OFF	Joystickleft/righttosele
⑩ Operate Dome Menu	ON	<<Operate Dome Menu	ON/OFF	Joystickleft/righttosele

**IRIS CLOSE to exit**

### 8.4 Password Logon OFF

<<Password Logon ON/OFF

**Joystick left/right to select**

## 9. Date/Time

<<Date/Time setup

**Press OPEN or Joystick left/right to enter**

**Note:** This is used for management of the system date&time. User can program the assignment of dome and operating time of dome via this option.

### 9.1 Date/Time Setup

<< Date/Time Setup

**Press OPEN or Joystick left/right to enter**

**Note:** This option is used for the users to modify date and time as well as to set the date and time display.

① Clock Display	ON	<< Clock Display	ON/OFF	Joystick left/right to select
② Date Display	ON	<< Date Display	ON/OFF	Joystick left/right to



**select**

③ Display Mode Y/M/D << Display Mode Y/M/D or D/M/Y **Joystick left/right to**

**select**

④ Date/Time Modify << Date/Time Modify **Press OPEN or Joystick left/right to**

**enter**

Refer to *Number Input Steps Instructions* to set date/time.

Date/Time Modify	
→ 1 Year	11
2 Month	3
3 Date	5
4 Day	Sat
5 Hour	17
6 Minute	53
7 Second	43
IRIS CLOSE to exit	

**Note:** Year: 2000~2099 (00~99)  
 Month: 1~12  
 Date: 1~ (28/29/30/31)  
 Day: Mon/Tue/Wed/Thurs/Fri/Sat/Sun  
 Hour: 0~23  
 Minute: 0~59  
 Second: 0~59

**IRIS CLOSE to exit**

## 9.2 Assignment

<< Assignment

**Press OPEN or Joystick left/right to**

**enter**

**Note:** Users could perform 8 options of assignment to be automatically executed for the dome system, namely to automatically execute the functions of the dome or the camera at the programmed designated time.

If an executing task is terminated by manual operation, it would be restarted if manual operation is not performed within 10 seconds after stop.

① Number 1  
<< Number 1~8

**Joystick left/right to**

**select**

**Note:** Assignment priority: 1-8 (High-Low)

② Program << Program

**Press OPEN or Joystick left/right to**

**enter**

A)Matter PreShot << Matter PreShot/Vector/Tour/PanScan/DayNight **Joystick left/right to**

**select**





B) Number 1 << Number

Press OPEN or Joystick left/right to

enter

Refer to *Number Input Steps Instructions* to set number

**Note:** Number is invalid to PanScan and DayNight optional function, it is used to select certain specific preset point and the track when PreShot/Vector/Tour is being selected by a specific assignment.

C) Mode Eachday << Mode Eachday

Joystick left/right to

select

Eachday/Workday/Weekend/Mon/Tue/Wed/Thurs/Fri/Sat/Sun

D) Start Time Setup << Start time setup

Press OPEN or Joystick left/right to

enter

Refer to *Number Input Steps Instructions* to set start time

Start Time Setup	
→ 1 Hour	0
2 Minute	0
3 Second	0
IRIS CLOSE to exit	

End Time Setup	
→ 1 Hour	23
2 Minute	59
3 Second	59
IRIS CLOSE to exit	

E) End Time Setup << End time setup

Press OPEN or Joystick left/right to

enter

Refer to *Number Input Steps Instructions* to set end time

**Note:** If the execution time for the assignment from start to end is set less than 3 seconds, this task will always be executed.

**IRIS CLOSE to exit**

③. Enable OFF

<< Enable ON/OFF

Joystick left/right to select

**Note:** If it is set up as ON, the assignment would be executed at the designated time. Otherwise, this assignment would not be executed. But all data would not be cleared.

**IRIS CLOSE to exit**



### 9.3 Power Timer

<< Power timer setup

**Press OPEN or Joystick left/right to**

**enter**

- Note:** A. User can perform timed startup and shutdown for the dome system.
- B. The interval period between startup and shutdown time is system startup operating status. While the shutdown time to startup time is the system shutdown status.
- C. Make sure that startup time is earlier than shutdown time, otherwise the system will always stay in the shutdown status.
- D. The system will wake for startup once the controlled command is received. If no controlled command received at an interval of 60 seconds under non-menu status, it would re-enter into shutdown status.
- E. The priority of Assignment is higher than that of the Power Timer. Namely, assignment will be first executed no matter it is under startup or shutdown status, and the Power Timer can only be entered after the execution of Assignment has been completed, while other non-Assignment functional operations or executions would be automatically discontinued or quitted before Power Timer is executed.

① Mode Off

<< Mode Off

**Joystick left/right to select**

Off/Eachday/Workday/Weekend/Mon/Tue/Wed/Thurs/Fri/Sat/Sun

② Power On Setup

<< Power On Setup

**Press OPEN or Joystick left/right to enter**

Refer to *Number Input Steps Instructions* to set power on time.

Power On Setup	
➔ 1 Hour	0
2 Minute	0
3 Second	0
IRIS CLOSE to exit	

Power Off Setup	
➔ 1 Hour	23
2 Minute	59
3 Second	59
IRIS CLOSE to exit	

③ Power Off Setup

<< Power Off Setup

**Press OPEN or Joystick left/right to enter**

Refer to *Number Input Steps Instructions* to set power off time.

**IRIS CLOSE to exit**



## Chapter Five Short-cut Operations and Specification of Dome Device

### 1. Short-cut operation table

System Preset Short-cut Operation Table	
PreShot 80 (Call 80)	Run PTZ Tour 1
PreShot 81 (Call 81)	Run PTZ Tour 2
PreShot 82 (Call 82)	Run PTZ Tour 3
PreShot 83 (Call 83)	Start VectorScan 1
PreShot 84 (Call 84)	Start VectorScan 2
PreShot 85 (Call 85)	Start VectorScan 3
PreShot 86 (Call 86)	Start VectorScan 4



PreShot 87 (Call 87)	Start VectorScan 5
PreShot 88 (Call 88)	Start VectorScan 6
PreShot 89 (Call 89)	Joysticks between freeze and unfreeze video
PreShot 90 (Call 90)	Setup the Menus and Camera
PreShot 91 (Call 91)	Invokes the Flashback Function
PreShot 92 (Call 92)	Administrator Logon
PreShot 93 (Call 93)	Operator Logon
PreShot 94 (Call 94)	Restart Dome Power Supply (Set No.94 preshot as power supply for shutting down the dome)

**Description of the preset point:**

Preset point of the position: 220

Function short-cut preset point: 51-63, 78-101

**Note:** Dome operation will be different due to controller’s different specs.

**Preset point setting:** Method 1: Firstly input “PRESET”, and then input the number of the preset point. Press “ENTER” in the end.(PRESET + No. + ENTER)  
 Method 2: Firstly input the number of preset point. The press “SHOT”.  
 Press “ON” in the end.(Preset point No. + Shot + ON)

**Call Preset point:** Method 1: Firstly input “CALL”. Then Input the number of the preset point.  
 Press “ENTER” in the end.(Call + Preset Point No. + ENTER)  
 Method 2: Firstly input the number of preset point. Then press “SHOT”.  
 Press “ACK” in the end.(Preset point No. + Shot + ACK)

**Clear Preset point:** Method 1: Firstly input “PRESET”. Then input the number of preset point.  
 Press “OFF” in the end.(PRESET + Preset point No. +OFF)  
 Method 2: Firstly input the preset point no. The press “SHOT”.  
 Press “OFF” in the end.( Preset point No. + SHOT + OFF)

**2. Users Logon Operation**

Please invoke No.92 preset position for administrator’s logon.

Please invoke No.93 preset position for the logon of operator.

**Factory Password:** Administrator: 000000 Operator: 111111

*Attention: Administrator password must be properly kept. While the dome shall be returned to the factory if it is lost.*

**3. OSD Menu of Speed Dome: 90+PRE Enter the OSD Menu of Speed Dome**



**4. OSD Menu of Camera: 57+PRE Enter the OSD Menu of Camera**

**5. Description of “cruise track” function:**

- a) When enter “**PRESET+51+Enter**”, the device is enabled system default cruise track. The device will auto scan point by point from No.1 preset position to No.16 preset position. If certain position has not been preset or been cleared after preset, “**cruise track**” will not scan them.
- b) Dwell time of the preset position is 2 seconds.
- c) About other 6 cruise tracks operation, please refer operation manual of the keyboard controller. Different controller is with different operation.

**6. Description of “Line-Scanning” function:**

- a) Dome device will auto line-scan between two specified points.
- b) User can set the start point by “**PRESET+52+Enter**” and end point by “**PRESET+53+Enter**”.
- c) Line scanning speed set: user keep a manual line scan speed three seconds above, then through “**CALL+51 +Enter**” to save the speed as line scan speed, use “**CALL+52+Enter**” to enable the line scan.
- d) Dwell time of line-scanning between “starting point” and “ending point” is 2 seconds.

**7. Intelligent manually pan continuous scan:**

When user use joystick for pan scan monitoring, keep manually 3 seconds, then press “**CALL+101+Enter**”, the dome can go on with the scan speed and monitor position automatically .

**Chapter Six Main Technical Parameters**

Dome Address	0~255
Pan Rotate Range	360 degree continous rotation
Tilt Rotate Range	0-90 degree continous rotation
Pan Manual Speed	<b>0-240 degree/second</b>
Tilt Manual Speed	<b>0-180 degree/second</b>
Call Preset Position	<b>240 degree/second</b>
Accuracy	±0.1 degree
Preset Position	256



## Operation Manual of Intelligent High Speed Dome Camera

IR Distance	150m
Language	English/Spanish etc.
Function Information Display	Dome Name, Preshot Name, PTZ Name, Sector Name
Intelligent Magnification	Manual scanning speed changes along with the automatic
Automatic Flip	10 degree forward tracking after 180 degree automatic flip when
Intelligent 3D Curise	Adjustable speed;vertical track could be changed immediately
Vector scan	8 groups
PTZ tour	6 tracks; each 120 s
Sector Operation Dispay	8areas
Privacy Zones	8 zones(depend on camera type)
Alarm	8 channels of input and 2 channels of output
Assignment Programming	8 options
User's Account Management	Strong user's management mechanism
Timed Startup/Shutdown	Random programming
Control Mode	RS-485 Bus
Communciation baudrate	2400/4800/9600/19200BPS
Power Supply	AC24V/3.5A
Operation Temperature	Indoor: -10~+50℃ Outdoor: -40~+60℃

## Chapter Seven Trouble Shooting of Dome Device

S.N.	Problem Description	Possible Reason	Troubleshooting	Remarks
1	After power on, no motion and no image.	Power cable is connected improperly.	Check if the power cable is connected to power of AC24V	Please follow the above basic system wiring strictly
		Fault of power PCB of dome device	Change the power PCB	
		slip ring power wires disconnected	Change slip ring	
		Fault of main control board	Change main control board	
2	After power on, the dome	Character monitor switch is	Switch on the character	About 45 seconds after



## Operation Manual of Intelligent High Speed Dome Camera

	device rotate normally, but no character nor image display	off	monitor according to the menu instruction	the dome device is power on.
		Improper connection between camera and dome device	Replace a FFC cable or a camera	
3	After self-test of the dome device, menu cannot be displayed	Wrong operation	CALL+90+ENTER open	After self-test, the menu can only be displayed when there is image display of the dome device
		Fault of OSD control board	Change OSD board	
4	Distorted character or image	Interfered by exterior electronic signal (noise) or the camera is directed to the monitor screen	Grounding the dome device or shut off the surrounding big electronic devices(electric, HF, signal generating) equipment, or rotate the camera	Shielded cable should be adopted for video cable
		System wrong function	Restart the dome device	
5	After power on, no self-test and motor is locked	The system setting is start self-test after receiving command and you can see the video on the screen	Connect the controller and set correct transmission protocol and baud rate as well as dome device address	There is character display in normal circumstance
6	Cannot stop pan rotation (rotate and stop alternatively)	OSD board is not properly connected with main control board or the photoelectric switch is broken	Fix OSD board again, if the problem still exists, then replace the OSD board	Pan interrupter should be at 2/3 of the central slot within photoelectric switch
		Pan interrupter is not in due position	Adjust the pan interrupter	
7	After normal working, it will rotate one circle when being controlled	The system is checking the data again	It is normal event	If this happens frequently, please adjust the pan interrupter or check if the connection is too tight.
8	Vertical range is not within $90\pm 2$ degree with large deviation	Fault occurs when the dome device is in tilt movement. It may be caused by obstacle of camera or other object, which lead to early tilt movement	Check and adjust the mechanical installation	
9	Self-test is normal, but cannot control	Wrong setting	Set the protocol, baud rate and address of dome device	
		Improper connection of control cable	Check the circuit	



## Operation Manual of Intelligent High Speed Dome Camera

<b>10</b>	Insensitive control of dome device	Overload or too long distance transmission	Add driver	Mostly happen in the connection
		Improper contact of control cable	Check the circuit	
		Slip ring is damaged	Replace slip ring	
		RS-485 protective discharge arresters broken	Change 485 protective discharge arresters	
<b>11</b>	Call out function fails	System failure caused by noise interference	Restart the dome device	
<b>12</b>	Auto action of dome device periodically	No transmission auto "call back" function is set to the dome device	Called this setting	
<b>13</b>	One dome working well while the other does not under identical operation	Something wrong with the setting or wiring	Check the setting and wiring again	

